



# basic education

Department:  
Basic Education  
**REPUBLIC OF SOUTH AFRICA**

**NATIONAL  
SENIOR CERTIFICATE**

**GRADE 12**

**PHYSICAL SCIENCES: CHEMISTRY (P2)**

**NOVEMBER 2016**

**MARKS: 150**

**TIME: 3 hours**

**This question paper consists of 18 pages and 4 data sheets.**

## INSTRUCTIONS AND INFORMATION

1. Write your centre number and examination number in the appropriate spaces on the ANSWER BOOK.
2. This question paper consists of TEN questions. Answer ALL the questions in the ANSWER BOOK.
3. Start EACH question on a NEW page in the ANSWER BOOK.
4. Number the answers correctly according to the numbering system used in this question paper.
5. Leave ONE line between two subquestions, for example between QUESTION 2.1 and QUESTION 2.2.
6. You may use a non-programmable calculator.
7. You may use appropriate mathematical instruments.
8. You are advised to use the attached DATA SHEETS.
9. Show ALL formulae and substitutions in ALL calculations.
10. Round off your final numerical answers to a minimum of TWO decimal places.
11. Give brief motivations, discussions et cetera where required.
12. Write neatly and legibly.

**QUESTION 1: MULTIPLE-CHOICE QUESTIONS**

Various options are provided as possible answers to the following questions. Write down the question number (1.1–1.10), choose the answer and make a cross (X) over the letter (A–D) of your choice in the ANSWER BOOK.

EXAMPLE:

1.11     A     B     C     D

1.1    In a chemical reaction an oxidising agent will ...

A    lose protons.

B    gain protons.

C    lose electrons.

D    gain electrons.

(2)

1.2    A catalyst is added to a reaction mixture at equilibrium.

Which ONE of the following statements about the effect of the catalyst is FALSE?

A    The rate of the forward reaction increases.

B    The rate of the reverse reaction increases.

C    The equilibrium position shifts to the right.

D    The equilibrium position remains unchanged.

(2)

1.3    What product will be formed when an alkene reacts with water vapour (H<sub>2</sub>O) in the presence of an acid catalyst?

A    Ester

B    Alkane

C    Alcohol

D    Aldehyde

(2)

1.4    Which ONE of the following represents a SUBSTITUTION REACTION?

A     $\text{CH}_2 = \text{CH}_2 + \text{HBr} \rightarrow \text{CH}_3\text{CH}_2\text{Br}$

B     $\text{CH}_2 = \text{CH}_2 + \text{H}_2\text{O} \rightarrow \text{CH}_3\text{CH}_2\text{OH}$

C     $\text{CH}_3\text{CH}_2\text{OH} \rightarrow \text{CH}_2 = \text{CH}_2 + \text{H}_2\text{O}$

D     $\text{CH}_3\text{CH}_2\text{OH} + \text{HBr} \rightarrow \text{CH}_3\text{CH}_2\text{Br} + \text{H}_2\text{O}$

(2)

1.5 Consider the two organic molecules **I** and **II** below.

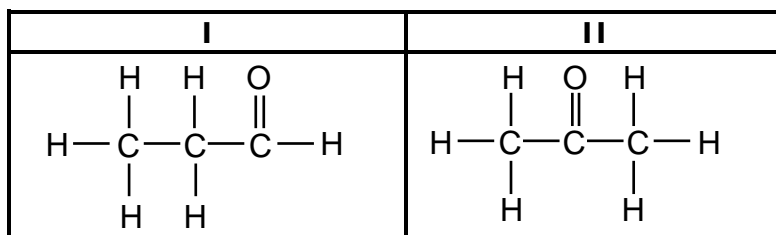

Which ONE of the following represents the homologous series to which compound **I** and compound **II** belong?

	<b>I</b>	<b>II</b>
A	Ketones	Alcohols
B	Aldehydes	Ketones
C	Aldehydes	Alcohols
D	Ketones	Aldehydes

(2)

1.6 Consider the balanced equations for three reactions represented below:

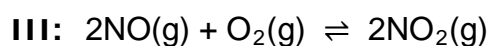
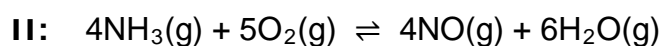
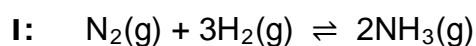

Which of the above reactions form(s) part of the Ostwald process?

A **I** only

B **II** only

C **III** only

D **II** and **III** only

(2)

1.7 Which ONE of the following pairs is NOT a conjugate acid-base pair?

A  $\text{H}_3\text{O}^+$  and  $\text{OH}^-$

B  $\text{NH}_4^+$  and  $\text{NH}_3$

C  $\text{H}_2\text{PO}_4^-$  and  $\text{HPO}_4^{2-}$

D  $\text{H}_2\text{CO}_3$  and  $\text{HCO}_3^-$

(2)

- 1.8 The reaction between hydrogen gas and iodine gas reaches equilibrium in a closed container according to the following balanced equation:

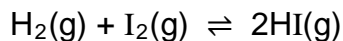

Which ONE of the graphs below shows the relationship between the amount of HI(g) at equilibrium and the pressure in the container at constant temperature?

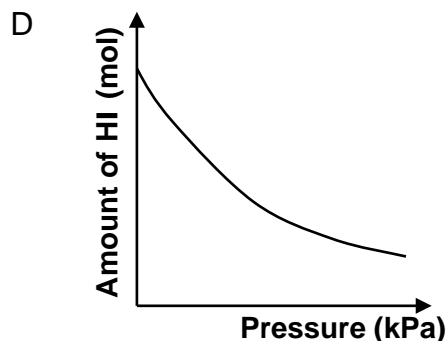
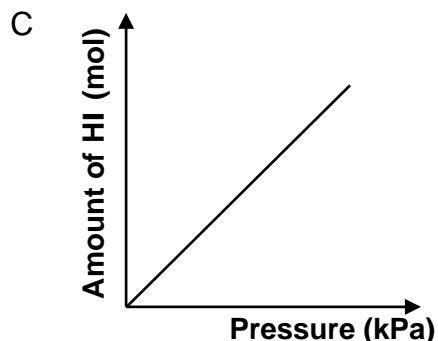
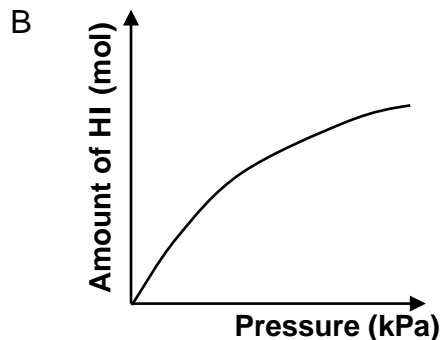
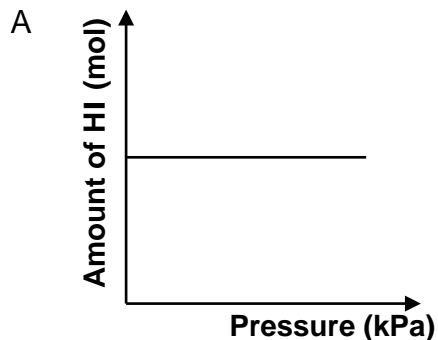

(2)

- 1.9 Which ONE of the equations below represents the half-reaction occurring at the CATHODE of an electrochemical cell that is used to electroplate an object?

- A  $\text{Ag} \rightarrow \text{Ag}^+ + \text{e}^-$   
 B  $\text{Cr}^{3+} + 3\text{e}^- \rightarrow \text{Cr}$   
 C  $\text{Cr}^{3+} + \text{e}^- \rightarrow \text{Cr}^{2+}$   
 D  $\text{Cu}^{2+} + \text{e}^- \rightarrow \text{Cu}^+$

(2)

- 1.10 Equal amounts of magnesium (Mg) powder react respectively with equal volumes and equal concentrations of  $\text{HCl}(\text{aq})$  and  $\text{H}_2\text{SO}_4(\text{aq})$ , as shown below.

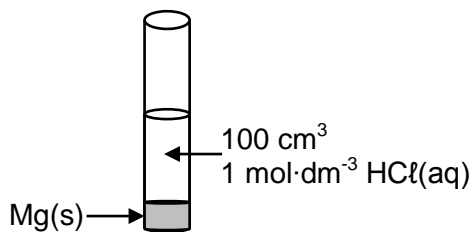

**Test tube X**

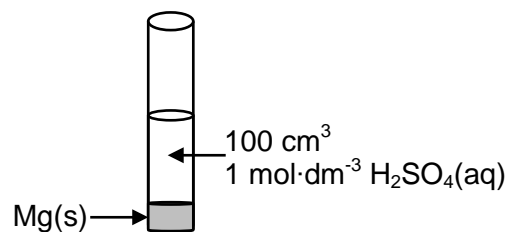

**Test tube Y**

The magnesium is in EXCESS.

Consider the following statements regarding these two reactions:

- I:** The initial rate of the reaction in test tube **X** equals the initial rate of the reaction in test tube **Y**.
- II:** After completion of the reactions, the mass of magnesium that remains in test tube **X** will be greater than that in test tube **Y**.
- III:** The amount of hydrogen gas formed in **X** is equal to the amount of hydrogen gas formed in **Y**.

Which of the above statements is/are TRUE?

- A **I** only
- B **II** only
- C **III** only
- D **I** and **III** only

(2)  
[20]

**QUESTION 2 (Start on a new page.)**

The letters **A** to **F** in the table below represent six organic compounds.

<b>A</b>	$  \begin{array}{c}  \text{H} \qquad \qquad \text{H} \\    \qquad \qquad   \\  \text{H}-\text{C}-\text{C}=\text{C}-\text{H} \\    \qquad \qquad   \\  \text{H} \qquad \qquad \text{H}-\text{C}-\text{H} \\    \\  \text{H}  \end{array}  $	<b>B</b>	Ethyl ethanoate
<b>C</b>	2,3-dibromo-3-methylpentane	<b>D</b>	Polyethene
<b>E</b>	$  \begin{array}{c}  \text{H} \qquad \text{O} \qquad \qquad \text{H} \\    \qquad    \qquad \qquad   \\  \text{H}-\text{C}-\text{C}-\text{O}-\text{C}-\text{H} \\    \qquad   \qquad \qquad   \\  \text{H} \qquad \text{H} \qquad \qquad \text{H}  \end{array}  $	<b>F</b>	$  \begin{array}{c}  \text{H} \qquad \text{H} \qquad \text{H} \qquad \text{O}-\text{H} \\    \qquad   \qquad   \qquad   \\  \text{H}-\text{C}-\text{C}-\text{C}-\text{C}=\text{O} \\    \qquad   \qquad   \\  \text{H} \qquad \text{H} \qquad \text{H}  \end{array}  $

2.1 Write down the LETTER that represents the following:

2.1.1 A hydrocarbon (1)

2.1.2 A functional isomer of compound **F** (1)

2.1.3 A compound which belongs to the same homologous series as compound **B** (1)

2.1.4 A plastic (1)

2.2 Write down the STRUCTURAL FORMULA of EACH of the following:

2.2.1 Compound **C** (3)

2.2.2 The acid used to prepare compound **B** (2)

2.2.3 The monomer used to make compound **D** (2)

2.3 Compound **A** reacts with an unknown reactant, **X**, to form 2-methylpropane.

Write down the:

2.3.1 NAME of reactant **X** (1)

2.3.2 Type of reaction that takes place (1)

**[13]**

**QUESTION 3 (Start on a new page.)**

The boiling points of three isomers are given in the table below.

	<b>ISOMERS</b>	<b>BOILING POINT (°C)</b>
<b>A</b>	2,2-dimethylpropane	9
<b>B</b>	2-methylbutane	28
<b>C</b>	pentane	36

- 3.1 Define the term *structural isomer*. (2)
- 3.2 What type of isomers (POSITIONAL, CHAIN or FUNCTIONAL) are these three compounds? (1)
- 3.3 Explain the trend in the boiling points from compound **A** to compound **C**. (3)
- 3.4 Which ONE of the three compounds (**A**, **B** or **C**) has the highest vapour pressure? Refer to the data in the table to give a reason for the answer. (2)
- 3.5 Use MOLECULAR FORMULAE and write down a balanced equation for the complete combustion of compound **B**. (3)

**[11]**



**QUESTION 4 (Start on a new page.)**

Butane (C<sub>4</sub>H<sub>10</sub>) is produced in industry by the THERMAL cracking of long-chain hydrocarbon molecules, as shown in the equation below. **X** represents an organic compound that is produced.

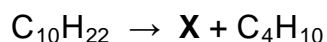

4.1 Write down:

4.1.1 ONE condition required for THERMAL cracking to take place (1)

4.1.2 The molecular formula of compound **X** (1)

4.1.3 The homologous series to which compound **X** belongs (1)

4.2 A mixture of the two gases, compound **X** and butane, is bubbled through bromine water, Br<sub>2</sub>(aq), in a conical flask, as illustrated below. THE REACTION IS CARRIED OUT IN A DARKENED ROOM.

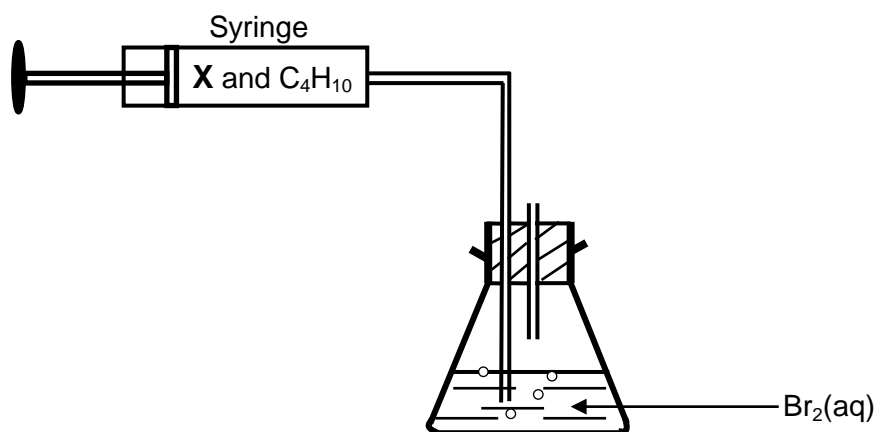

The colour of the bromine water changes from reddish brown to colourless when the mixture of the two gases is bubbled through it.

Which ONE of the gases (**X** or BUTANE) decolorises the bromine water? Explain the answer. (4)

- 4.3 Study the flow diagram below, which represents various organic reactions, and answer the questions that follow.

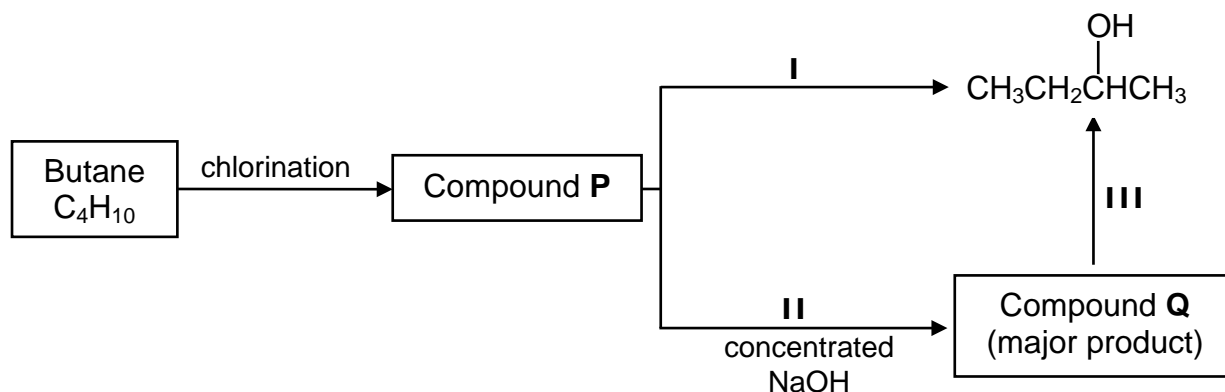

Write down the:

- 4.3.1 IUPAC name of compound **P** (2)
- 4.3.2 Type of reaction labelled **I** (1)
- 4.3.3 Structural formula of compound **Q** (2)
- 4.3.4 The type of addition reaction represented by reaction **III** (1)
- [13]**

**QUESTION 5 (Start on a new page.)**

Hydrogen peroxide,  $\text{H}_2\text{O}_2$ , decomposes to produce water and oxygen according to the following balanced equation:

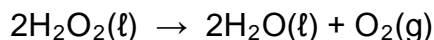

5.1 The activation energy ( $E_A$ ) for this reaction is 75 kJ and the heat of reaction ( $\Delta H$ ) is  $-196$  kJ.

5.1.1 Define the term *activation energy*. (2)

5.1.2 Redraw the set of axes below in your ANSWER BOOK and then complete the potential energy diagram for this reaction.

Indicate the value of the potential energy of the following on the y-axis:

- Activated complex
- Products

(The graph does NOT have to be drawn to scale.)

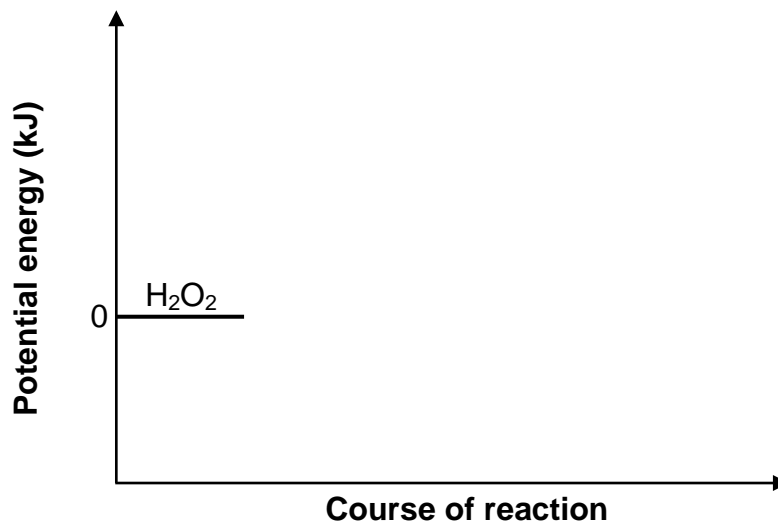

(3)

When powdered manganese dioxide is added to the reaction mixture, the rate of the reaction increases.

5.1.3 On the graph drawn for QUESTION 5.1.2, use broken lines to show the path of the reaction when the manganese dioxide is added. (2)

5.1.4 Use the collision theory to explain how manganese dioxide influences the rate of decomposition of hydrogen peroxide. (3)

5.2 Graphs **A** and **B** below were obtained for the volume of oxygen produced over time under different conditions.

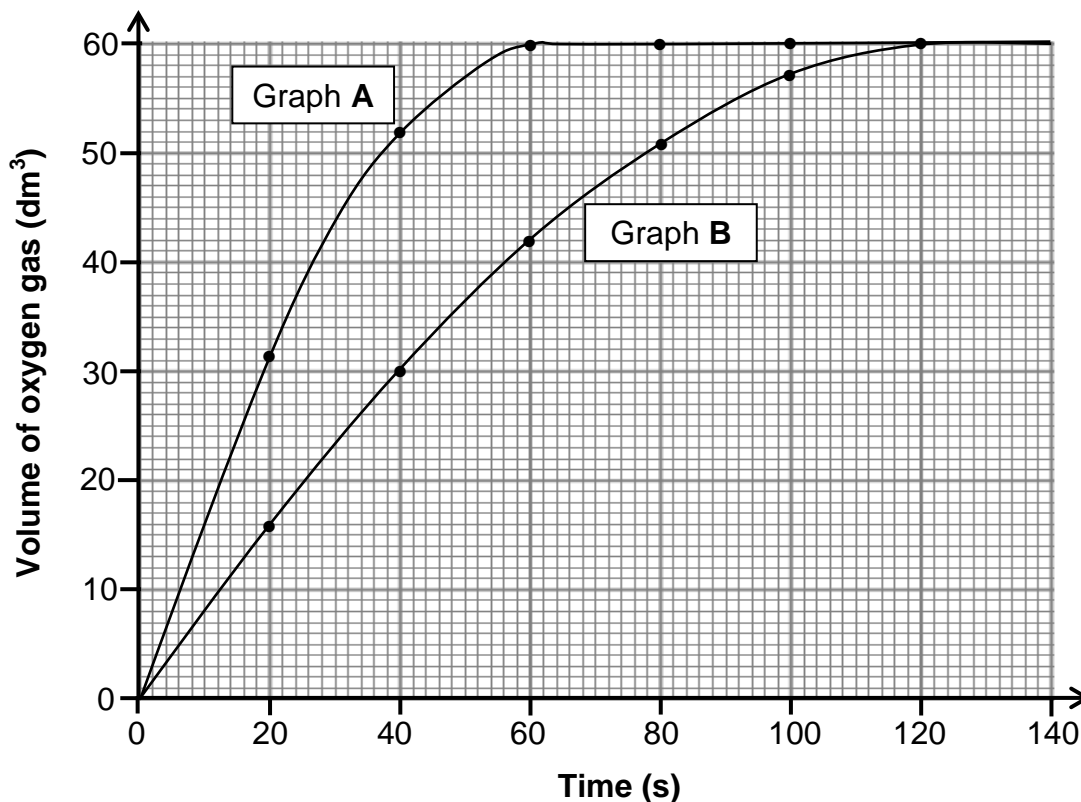

- 5.2.1 Calculate the average rate of the reaction (in  $\text{dm}^3 \cdot \text{s}^{-1}$ ) between  $t = 10$  s and  $t = 40$  s for graph **A**. (3)
- 5.2.2 Use the information in graph **A** to calculate the mass of hydrogen peroxide used in the reaction. Assume that all the hydrogen peroxide decomposed. Use  $24 \text{ dm}^3 \cdot \text{mol}^{-1}$  as the molar volume of oxygen. (4)
- 5.2.3 How does the mass of hydrogen peroxide used to obtain graph **B** compare to that used to obtain graph **A**? Choose from GREATER THAN, SMALLER THAN or EQUAL TO. (1)

- 5.3 Three energy distribution curves for the oxygen gas produced under different conditions are shown in the graph below.

The curve with the solid line represents 1 mol of oxygen gas at 90 °C.

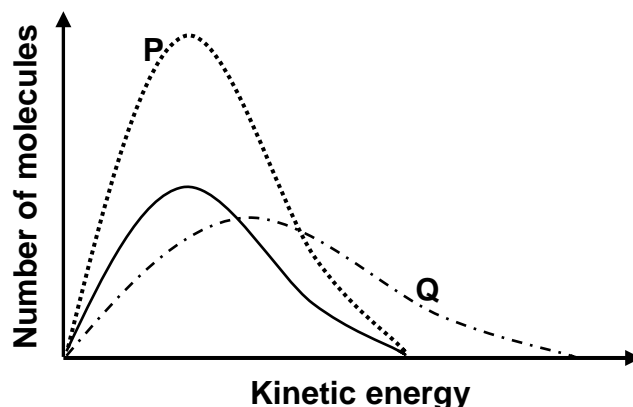

Choose the curve (**P** or **Q**) that best represents EACH of the following situations:

5.3.1 1 mol of oxygen gas produced at 120 °C (1)

5.3.2 2 moles of oxygen gas produced at 90 °C (1)  
[20]

**QUESTION 6 (Start on a new page.)**

Hydrogen gas,  $\text{H}_2(\text{g})$ , reacts with sulphur powder,  $\text{S}(\text{s})$ , according to the following balanced equation:

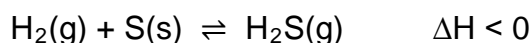

The system reaches equilibrium at 90 °C.

6.1 Define the term *chemical equilibrium*. (2)

6.2 How will EACH of the following changes affect the number of moles of  $\text{H}_2\text{S}(\text{g})$  at equilibrium?

Choose from INCREASES, DECREASES or REMAINS THE SAME.

6.2.1 The addition of more sulphur (1)

6.2.2 An increase in temperature  
Use Le Chatelier's principle to explain the answer. (4)

6.3 The sketch graph below was obtained for the equilibrium mixture.

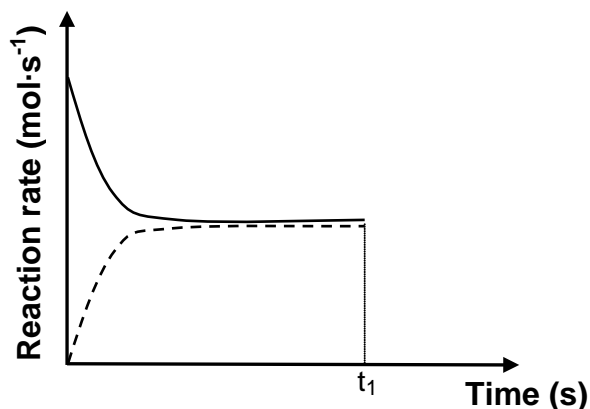

A catalyst is added to the equilibrium mixture at time  $t_1$ .

Redraw the graph above in your ANSWER BOOK. On the same set of axes, complete the graph showing the effect of the catalyst on the reaction rates. (2)

Initially 0,16 mol  $\text{H}_2(\text{g})$  and excess  $\text{S}(\text{s})$  are sealed in a  $2 \text{ dm}^3$  container and the system is allowed to reach equilibrium at  $90^\circ\text{C}$ .

An exact amount of  $\text{Pb}(\text{NO}_3)_2$  solution is now added to the container so that ALL the  $\text{H}_2\text{S}(\text{g})$  present in the container at EQUILIBRIUM is converted to  $\text{PbS}(\text{s})$  according to the following balanced equation:

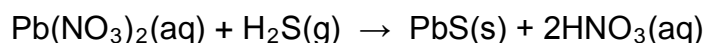

The mass of the  $\text{PbS}$  precipitate is 2,39 g.

6.4 Calculate the equilibrium constant  $K_c$  for the reaction  $\text{H}_2(\text{g}) + \text{S}(\text{s}) \rightleftharpoons \text{H}_2\text{S}(\text{g})$  at  $90^\circ\text{C}$ . (9)

**[18]**

**QUESTION 7 (Start on a new page.)**

7.1 A learner dissolves ammonium chloride ( $\text{NH}_4\text{Cl}$ ) crystals in water and measures the pH of the solution.

7.1.1 Define the term *hydrolysis* of a salt. (2)

7.1.2 Will the pH of the solution be GREATER THAN, SMALLER THAN or EQUAL TO 7? Write a relevant equation to support your answer. (3)

7.2 A sulphuric acid solution is prepared by dissolving 7,35 g of  $\text{H}_2\text{SO}_4(\ell)$  in  $500 \text{ cm}^3$  of water.

7.2.1 Calculate the number of moles of  $\text{H}_2\text{SO}_4$  present in this solution. (2)

Sodium hydroxide ( $\text{NaOH}$ ) pellets are added to the  $500 \text{ cm}^3$   $\text{H}_2\text{SO}_4$  solution.

The balanced equation for the reaction is:

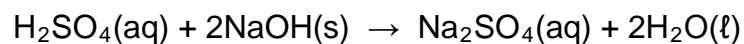

After completion of the reaction, the pH of the solution was found to be 1,3. Assume complete ionisation of  $\text{H}_2\text{SO}_4$ .

7.2.2 Calculate the mass of  $\text{NaOH}$  added to the  $\text{H}_2\text{SO}_4$  solution. Assume that the volume of the solution does not change. (9)

**[16]**

**QUESTION 8 (Start on a new page.)**

- 8.1 A nickel (Ni) rod is placed in a beaker containing a silver nitrate solution,  $\text{AgNO}_3(\text{aq})$  and a reaction takes place.

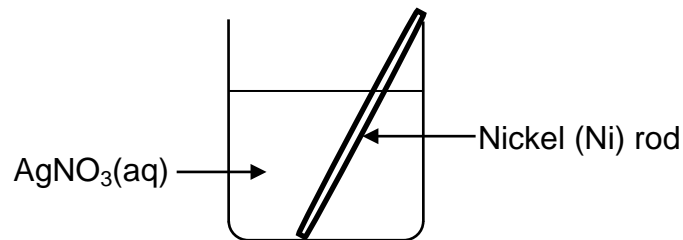

Write down the:

- 8.1.1 NAME or FORMULA of the electrolyte (1)
- 8.1.2 Oxidation half-reaction that takes place (2)
- 8.1.3 Balanced equation for the net (overall) redox reaction that takes place (3)
- 8.2 A galvanic cell is now set up using a nickel half-cell and a silver half-cell.

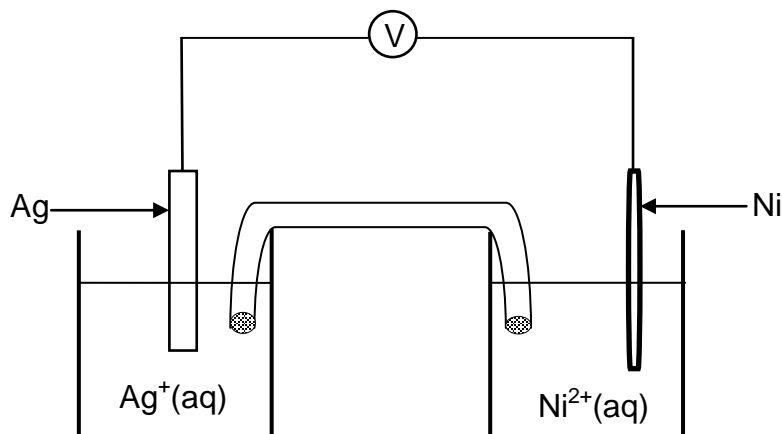

- 8.2.1 Which electrode (**Ni** or **Ag**) must be connected to the negative terminal of the voltmeter? Give a reason for the answer. (2)
- 8.2.2 Write down the cell notation for the galvanic cell above. (3)
- 8.2.3 Calculate the initial reading on the voltmeter if the cell functions under standard conditions. (4)
- 8.2.4 How will the voltmeter reading in QUESTION 8.2.3 be affected if the concentration of the silver ions is increased? Choose from INCREASES, DECREASES or REMAINS THE SAME. (1)

**[16]**



**QUESTION 9 (Start on a new page.)**

In the electrochemical cell below, carbon electrodes are used during the electrolysis of a concentrated sodium chloride solution.

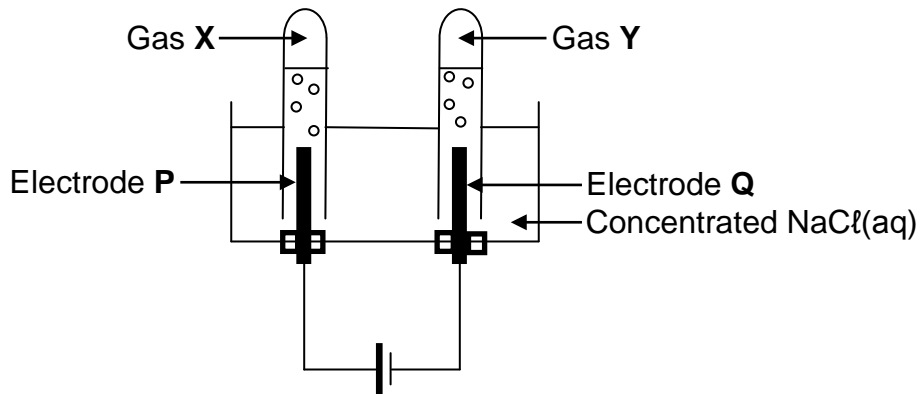

The balanced equation for the net (overall) cell reaction is:

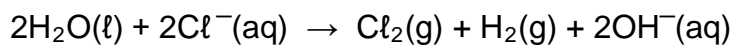

- 9.1 Is the reaction EXOTHERMIC or ENDOTHERMIC? (1)
- 9.2 Is electrode **P** the ANODE or the CATHODE? Give a reason for the answer. (2)
- 9.3 Write down the:
- 9.3.1 NAME or FORMULA of gas **X** (1)
- 9.3.2 NAME or FORMULA of gas **Y** (1)
- 9.3.3 Reduction half-reaction (2)
- 9.4 Is the solution in the cell ACIDIC or ALKALINE (BASIC) after completion of the reaction? Give a reason for the answer. (2)
- [9]**

**QUESTION 10 (Start on a new page.)**

10.1 The flow diagram below shows the processes involved in the industrial preparation of fertiliser **Q**.

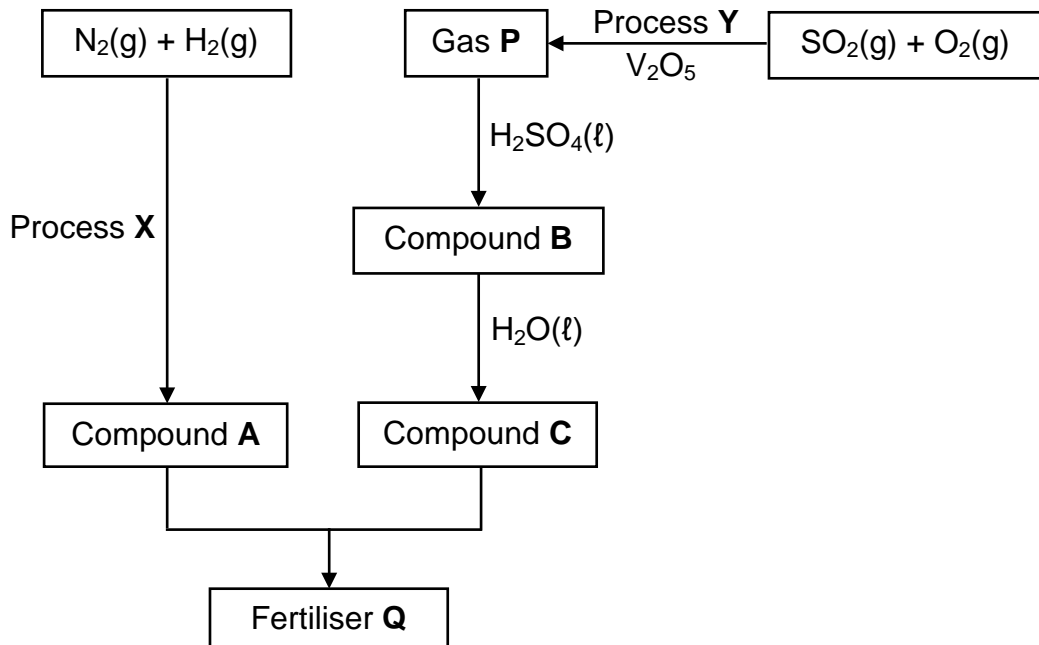

Write down the:

- 10.1.1 Name of process **X** (1)
- 10.1.2 Name of process **Y** (1)
- 10.1.3 NAME or FORMULA of gas **P** (1)
- 10.1.4 Balanced equation for the formation of compound **B** (3)
- 10.1.5 Balanced equation for the formation of fertiliser **Q** (4)

10.2 The diagram below shows a bag of NPK fertiliser of which the NPK ratio is unknown. It is found that the mass of nitrogen in the bag is 4,11 kg and the mass of phosphorus is 0,51 kg.

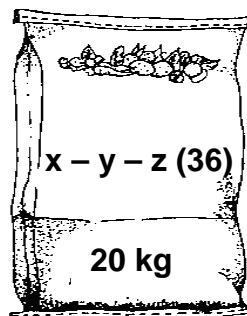

Calculate the NPK ratio of the fertiliser.

(4)  
[14]

**TOTAL: 150**

**DATA FOR PHYSICAL SCIENCES GRADE 12  
PAPER 2 (CHEMISTRY)**

**GEGEWENS VIR FISIESTE WETENSKAPPE GRAAD 12  
VRAESTEL 2 (CHEMIE)**

**TABLE 1: PHYSICAL CONSTANTS/TABEL 1: FISIESTE KONSTANTES**

NAME/NAAM	SYMBOL/SIMBOOL	VALUE/WAARDE
Standard pressure <i>Standaarddruk</i>	$p^\theta$	$1,013 \times 10^5 \text{ Pa}$
Molar gas volume at STP <i>Molêre gasvolume by STD</i>	$V_m$	$22,4 \text{ dm}^3 \cdot \text{mol}^{-1}$
Standard temperature <i>Standaardtemperatuur</i>	$T^\theta$	273 K
Charge on electron <i>Lading op elektron</i>	$e$	$-1,6 \times 10^{-19} \text{ C}$
Avogadro's constant <i>Avogadro-konstante</i>	$N_A$	$6,02 \times 10^{23} \text{ mol}^{-1}$

**TABLE 2: FORMULAE/TABEL 2: FORMULES**

$n = \frac{m}{M}$	$n = \frac{N}{N_A}$
$c = \frac{n}{V}$ or/of $c = \frac{m}{MV}$	$n = \frac{V}{V_m}$
$\frac{c_a v_a}{c_b v_b} = \frac{n_a}{n_b}$	$\text{pH} = -\log[\text{H}_3\text{O}^+]$
$K_w = [\text{H}_3\text{O}^+][\text{OH}^-] = 1 \times 10^{-14}$ at/by 298 K	
$E_{\text{cell}}^\theta = E_{\text{cathode}}^\theta - E_{\text{anode}}^\theta$ / $E_{\text{sel}}^\theta = E_{\text{katode}}^\theta - E_{\text{anode}}^\theta$	
or/of $E_{\text{cell}}^\theta = E_{\text{reduction}}^\theta - E_{\text{oxidation}}^\theta$ / $E_{\text{sel}}^\theta = E_{\text{reduksie}}^\theta - E_{\text{oksidasie}}^\theta$	
or/of $E_{\text{cell}}^\theta = E_{\text{oxidising agent}}^\theta - E_{\text{reducing agent}}^\theta$ / $E_{\text{sel}}^\theta = E_{\text{oksideermiddel}}^\theta - E_{\text{reduseermiddel}}^\theta$	

**TABLE 3: THE PERIODIC TABLE OF ELEMENTS**  
**TABEL 3: DIE PERIODIEKE TABEL VAN ELEMENTE**

1 (I)	2 (II)	3	4	5	6	7	8	9	10	11	12	13 (III)	14 (IV)	15 (V)	16 (VI)	17 (VII)	18 (VIII)																												
2,1 1 <b>H</b> 1																	2 <b>He</b> 4																												
1,0 3 <b>Li</b> 7	1,5 4 <b>Be</b> 9											2,0 5 <b>B</b> 11	2,5 6 <b>C</b> 12	3,0 7 <b>N</b> 14	3,5 8 <b>O</b> 16	4,0 9 <b>F</b> 19	10 <b>Ne</b> 20																												
0,9 11 <b>Na</b> 23	1,2 12 <b>Mg</b> 24											1,5 13 <b>Al</b> 27	1,8 14 <b>Si</b> 28	2,1 15 <b>P</b> 31	2,5 16 <b>S</b> 32	3,0 17 <b>Cl</b> 35,5	18 <b>Ar</b> 40																												
0,8 19 <b>K</b> 39	1,0 20 <b>Ca</b> 40	1,3 21 <b>Sc</b> 45	1,5 22 <b>Ti</b> 48	1,6 23 <b>V</b> 51	1,6 24 <b>Cr</b> 52	1,5 25 <b>Mn</b> 55	1,8 26 <b>Fe</b> 56	1,8 27 <b>Co</b> 59	1,8 28 <b>Ni</b> 59	1,9 29 <b>Cu</b> 63,5	1,6 30 <b>Zn</b> 65	1,6 31 <b>Ga</b> 70	1,8 32 <b>Ge</b> 73	2,0 33 <b>As</b> 75	2,4 34 <b>Se</b> 79	2,8 35 <b>Br</b> 80	36 <b>Kr</b> 84																												
0,8 37 <b>Rb</b> 86	1,0 38 <b>Sr</b> 88	1,2 39 <b>Y</b> 89	1,4 40 <b>Zr</b> 91	1,6 41 <b>Nb</b> 92	1,8 42 <b>Mo</b> 96	1,9 43 <b>Tc</b> 99	2,2 44 <b>Ru</b> 101	2,2 45 <b>Rh</b> 103	2,2 46 <b>Pd</b> 106	1,9 47 <b>Ag</b> 108	1,7 48 <b>Cd</b> 112	1,7 49 <b>In</b> 115	1,8 50 <b>Sn</b> 119	1,9 51 <b>Sb</b> 122	2,1 52 <b>Te</b> 128	2,5 53 <b>I</b> 127	54 <b>Xe</b> 131																												
0,7 55 <b>Cs</b> 133	0,9 56 <b>Ba</b> 137	57 <b>La</b> 139	1,6 72 <b>Hf</b> 179	1,6 73 <b>Ta</b> 181	1,8 74 <b>W</b> 184	1,9 75 <b>Re</b> 186	2,2 76 <b>Os</b> 190	2,2 77 <b>Ir</b> 192	2,2 78 <b>Pt</b> 195	1,9 79 <b>Au</b> 197	1,7 80 <b>Hg</b> 201	1,8 81 <b>Tl</b> 204	1,8 82 <b>Pb</b> 207	1,9 83 <b>Bi</b> 209	2,0 84 <b>Po</b>	2,5 85 <b>At</b>	86 <b>Rn</b>																												
0,7 87 <b>Fr</b>	0,9 88 <b>Ra</b> 226	89 <b>Ac</b>																																											
<table border="1" style="width: 100%; border-collapse: collapse; text-align: center;"> <tr> <td>58 <b>Ce</b> 140</td> <td>59 <b>Pr</b> 141</td> <td>60 <b>Nd</b> 144</td> <td>61 <b>Pm</b></td> <td>62 <b>Sm</b> 150</td> <td>63 <b>Eu</b> 152</td> <td>64 <b>Gd</b> 157</td> <td>65 <b>Tb</b> 159</td> <td>66 <b>Dy</b> 163</td> <td>67 <b>Ho</b> 165</td> <td>68 <b>Er</b> 167</td> <td>69 <b>Tm</b> 169</td> <td>70 <b>Yb</b> 173</td> <td>71 <b>Lu</b> 175</td> </tr> <tr> <td>90 <b>Th</b> 232</td> <td>91 <b>Pa</b></td> <td>92 <b>U</b> 238</td> <td>93 <b>Np</b></td> <td>94 <b>Pu</b></td> <td>95 <b>Am</b></td> <td>96 <b>Cm</b></td> <td>97 <b>Bk</b></td> <td>98 <b>Cf</b></td> <td>99 <b>Es</b></td> <td>100 <b>Fm</b></td> <td>101 <b>Md</b></td> <td>102 <b>No</b></td> <td>103 <b>Lr</b></td> </tr> </table>																		58 <b>Ce</b> 140	59 <b>Pr</b> 141	60 <b>Nd</b> 144	61 <b>Pm</b>	62 <b>Sm</b> 150	63 <b>Eu</b> 152	64 <b>Gd</b> 157	65 <b>Tb</b> 159	66 <b>Dy</b> 163	67 <b>Ho</b> 165	68 <b>Er</b> 167	69 <b>Tm</b> 169	70 <b>Yb</b> 173	71 <b>Lu</b> 175	90 <b>Th</b> 232	91 <b>Pa</b>	92 <b>U</b> 238	93 <b>Np</b>	94 <b>Pu</b>	95 <b>Am</b>	96 <b>Cm</b>	97 <b>Bk</b>	98 <b>Cf</b>	99 <b>Es</b>	100 <b>Fm</b>	101 <b>Md</b>	102 <b>No</b>	103 <b>Lr</b>
58 <b>Ce</b> 140	59 <b>Pr</b> 141	60 <b>Nd</b> 144	61 <b>Pm</b>	62 <b>Sm</b> 150	63 <b>Eu</b> 152	64 <b>Gd</b> 157	65 <b>Tb</b> 159	66 <b>Dy</b> 163	67 <b>Ho</b> 165	68 <b>Er</b> 167	69 <b>Tm</b> 169	70 <b>Yb</b> 173	71 <b>Lu</b> 175																																
90 <b>Th</b> 232	91 <b>Pa</b>	92 <b>U</b> 238	93 <b>Np</b>	94 <b>Pu</b>	95 <b>Am</b>	96 <b>Cm</b>	97 <b>Bk</b>	98 <b>Cf</b>	99 <b>Es</b>	100 <b>Fm</b>	101 <b>Md</b>	102 <b>No</b>	103 <b>Lr</b>																																

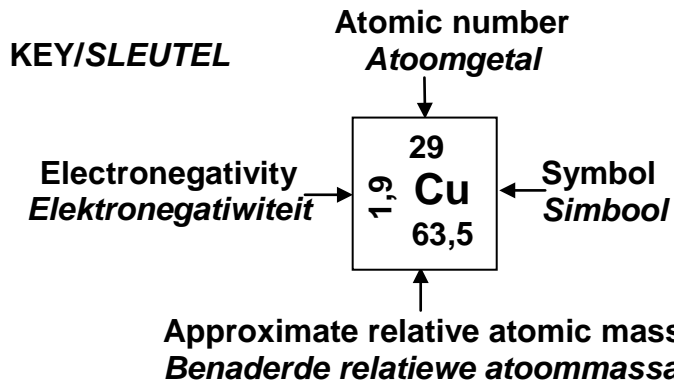

**TABLE 4A: STANDARD REDUCTION POTENTIALS**  
**TABEL 4A: STANDAARDREDUKSIEPOTENSIALE**

Half-reactions/ <i>Halfreaksies</i>	$E^{\ominus}$ (V)
$F_2(g) + 2e^- \rightleftharpoons 2F^-$	+ 2,87
$Co^{3+} + e^- \rightleftharpoons Co^{2+}$	+ 1,81
$H_2O_2 + 2H^+ + 2e^- \rightleftharpoons 2H_2O$	+1,77
$MnO_4^- + 8H^+ + 5e^- \rightleftharpoons Mn^{2+} + 4H_2O$	+ 1,51
$Cl_2(g) + 2e^- \rightleftharpoons 2Cl^-$	+ 1,36
$Cr_2O_7^{2-} + 14H^+ + 6e^- \rightleftharpoons 2Cr^{3+} + 7H_2O$	+ 1,33
$O_2(g) + 4H^+ + 4e^- \rightleftharpoons 2H_2O$	+ 1,23
$MnO_2 + 4H^+ + 2e^- \rightleftharpoons Mn^{2+} + 2H_2O$	+ 1,23
$Pt^{2+} + 2e^- \rightleftharpoons Pt$	+ 1,20
$Br_2(l) + 2e^- \rightleftharpoons 2Br^-$	+ 1,07
$NO_3^- + 4H^+ + 3e^- \rightleftharpoons NO(g) + 2H_2O$	+ 0,96
$Hg^{2+} + 2e^- \rightleftharpoons Hg(l)$	+ 0,85
$Ag^+ + e^- \rightleftharpoons Ag$	+ 0,80
$NO_3^- + 2H^+ + e^- \rightleftharpoons NO_2(g) + H_2O$	+ 0,80
$Fe^{3+} + e^- \rightleftharpoons Fe^{2+}$	+ 0,77
$O_2(g) + 2H^+ + 2e^- \rightleftharpoons H_2O_2$	+ 0,68
$I_2 + 2e^- \rightleftharpoons 2I^-$	+ 0,54
$Cu^+ + e^- \rightleftharpoons Cu$	+ 0,52
$SO_2 + 4H^+ + 4e^- \rightleftharpoons S + 2H_2O$	+ 0,45
$2H_2O + O_2 + 4e^- \rightleftharpoons 4OH^-$	+ 0,40
$Cu^{2+} + 2e^- \rightleftharpoons Cu$	+ 0,34
$SO_4^{2-} + 4H^+ + 2e^- \rightleftharpoons SO_2(g) + 2H_2O$	+ 0,17
$Cu^{2+} + e^- \rightleftharpoons Cu^+$	+ 0,16
$Sn^{4+} + 2e^- \rightleftharpoons Sn^{2+}$	+ 0,15
$S + 2H^+ + 2e^- \rightleftharpoons H_2S(g)$	+ 0,14
<b><math>2H^+ + 2e^- \rightleftharpoons H_2(g)</math></b>	<b>0,00</b>
$Fe^{3+} + 3e^- \rightleftharpoons Fe$	- 0,06
$Pb^{2+} + 2e^- \rightleftharpoons Pb$	- 0,13
$Sn^{2+} + 2e^- \rightleftharpoons Sn$	- 0,14
$Ni^{2+} + 2e^- \rightleftharpoons Ni$	- 0,27
$Co^{2+} + 2e^- \rightleftharpoons Co$	- 0,28
$Cd^{2+} + 2e^- \rightleftharpoons Cd$	- 0,40
$Cr^{3+} + e^- \rightleftharpoons Cr^{2+}$	- 0,41
$Fe^{2+} + 2e^- \rightleftharpoons Fe$	- 0,44
$Cr^{3+} + 3e^- \rightleftharpoons Cr$	- 0,74
$Zn^{2+} + 2e^- \rightleftharpoons Zn$	- 0,76
$2H_2O + 2e^- \rightleftharpoons H_2(g) + 2OH^-$	- 0,83
$Cr^{2+} + 2e^- \rightleftharpoons Cr$	- 0,91
$Mn^{2+} + 2e^- \rightleftharpoons Mn$	- 1,18
$Al^{3+} + 3e^- \rightleftharpoons Al$	- 1,66
$Mg^{2+} + 2e^- \rightleftharpoons Mg$	- 2,36
$Na^+ + e^- \rightleftharpoons Na$	- 2,71
$Ca^{2+} + 2e^- \rightleftharpoons Ca$	- 2,87
$Sr^{2+} + 2e^- \rightleftharpoons Sr$	- 2,89
$Ba^{2+} + 2e^- \rightleftharpoons Ba$	- 2,90
$Cs^+ + e^- \rightleftharpoons Cs$	- 2,92
$K^+ + e^- \rightleftharpoons K$	- 2,93
$Li^+ + e^- \rightleftharpoons Li$	- 3,05

Increasing oxidising ability/*Toenemende oksiderende vermoë*

Increasing reducing ability/*Toenemende reduserende vermoë*

**TABLE 4B: STANDARD REDUCTION POTENTIALS**  
**TABEL 4B: STANDAARDREDUKSIEPOTENSIALE**

Increasing oxidising ability/Toenemende oksiderende vermoë

Half-reactions/ <i>Halfreaksies</i>	$E^{\ominus}$ (V)
$\text{Li}^+ + e^- \rightleftharpoons \text{Li}$	-3,05
$\text{K}^+ + e^- \rightleftharpoons \text{K}$	-2,93
$\text{Cs}^+ + e^- \rightleftharpoons \text{Cs}$	-2,92
$\text{Ba}^{2+} + 2e^- \rightleftharpoons \text{Ba}$	-2,90
$\text{Sr}^{2+} + 2e^- \rightleftharpoons \text{Sr}$	-2,89
$\text{Ca}^{2+} + 2e^- \rightleftharpoons \text{Ca}$	-2,87
$\text{Na}^+ + e^- \rightleftharpoons \text{Na}$	-2,71
$\text{Mg}^{2+} + 2e^- \rightleftharpoons \text{Mg}$	-2,36
$\text{Al}^{3+} + 3e^- \rightleftharpoons \text{Al}$	-1,66
$\text{Mn}^{2+} + 2e^- \rightleftharpoons \text{Mn}$	-1,18
$\text{Cr}^{2+} + 2e^- \rightleftharpoons \text{Cr}$	-0,91
$2\text{H}_2\text{O} + 2e^- \rightleftharpoons \text{H}_2(\text{g}) + 2\text{OH}^-$	-0,83
$\text{Zn}^{2+} + 2e^- \rightleftharpoons \text{Zn}$	-0,76
$\text{Cr}^{3+} + 3e^- \rightleftharpoons \text{Cr}$	-0,74
$\text{Fe}^{2+} + 2e^- \rightleftharpoons \text{Fe}$	-0,44
$\text{Cr}^{3+} + e^- \rightleftharpoons \text{Cr}^{2+}$	-0,41
$\text{Cd}^{2+} + 2e^- \rightleftharpoons \text{Cd}$	-0,40
$\text{Co}^{2+} + 2e^- \rightleftharpoons \text{Co}$	-0,28
$\text{Ni}^{2+} + 2e^- \rightleftharpoons \text{Ni}$	-0,27
$\text{Sn}^{2+} + 2e^- \rightleftharpoons \text{Sn}$	-0,14
$\text{Pb}^{2+} + 2e^- \rightleftharpoons \text{Pb}$	-0,13
$\text{Fe}^{3+} + 3e^- \rightleftharpoons \text{Fe}$	-0,06
<b><math>2\text{H}^+ + 2e^- \rightleftharpoons \text{H}_2(\text{g})</math></b>	<b>0,00</b>
$\text{S} + 2\text{H}^+ + 2e^- \rightleftharpoons \text{H}_2\text{S}(\text{g})$	+0,14
$\text{Sn}^{4+} + 2e^- \rightleftharpoons \text{Sn}^{2+}$	+0,15
$\text{Cu}^{2+} + e^- \rightleftharpoons \text{Cu}^+$	+0,16
$\text{SO}_4^{2-} + 4\text{H}^+ + 2e^- \rightleftharpoons \text{SO}_2(\text{g}) + 2\text{H}_2\text{O}$	+0,17
$\text{Cu}^{2+} + 2e^- \rightleftharpoons \text{Cu}$	+0,34
$2\text{H}_2\text{O} + \text{O}_2 + 4e^- \rightleftharpoons 4\text{OH}^-$	+0,40
$\text{SO}_2 + 4\text{H}^+ + 4e^- \rightleftharpoons \text{S} + 2\text{H}_2\text{O}$	+0,45
$\text{Cu}^+ + e^- \rightleftharpoons \text{Cu}$	+0,52
$\text{I}_2 + 2e^- \rightleftharpoons 2\text{I}^-$	+0,54
$\text{O}_2(\text{g}) + 2\text{H}^+ + 2e^- \rightleftharpoons \text{H}_2\text{O}_2$	+0,68
$\text{Fe}^{3+} + e^- \rightleftharpoons \text{Fe}^{2+}$	+0,77
$\text{NO}_3^- + 2\text{H}^+ + e^- \rightleftharpoons \text{NO}_2(\text{g}) + \text{H}_2\text{O}$	+0,80
$\text{Ag}^+ + e^- \rightleftharpoons \text{Ag}$	+0,80
$\text{Hg}^{2+} + 2e^- \rightleftharpoons \text{Hg}(\ell)$	+0,85
$\text{NO}_3^- + 4\text{H}^+ + 3e^- \rightleftharpoons \text{NO}(\text{g}) + 2\text{H}_2\text{O}$	+0,96
$\text{Br}_2(\ell) + 2e^- \rightleftharpoons 2\text{Br}^-$	+1,07
$\text{Pt}^{2+} + 2e^- \rightleftharpoons \text{Pt}$	+1,20
$\text{MnO}_2 + 4\text{H}^+ + 2e^- \rightleftharpoons \text{Mn}^{2+} + 2\text{H}_2\text{O}$	+1,23
$\text{O}_2(\text{g}) + 4\text{H}^+ + 4e^- \rightleftharpoons 2\text{H}_2\text{O}$	+1,23
$\text{Cr}_2\text{O}_7^{2-} + 14\text{H}^+ + 6e^- \rightleftharpoons 2\text{Cr}^{3+} + 7\text{H}_2\text{O}$	+1,33
$\text{Cl}_2(\text{g}) + 2e^- \rightleftharpoons 2\text{Cl}^-$	+1,36
$\text{MnO}_4^- + 8\text{H}^+ + 5e^- \rightleftharpoons \text{Mn}^{2+} + 4\text{H}_2\text{O}$	+1,51
$\text{H}_2\text{O}_2 + 2\text{H}^+ + 2e^- \rightleftharpoons 2\text{H}_2\text{O}$	+1,77
$\text{Co}^{3+} + e^- \rightleftharpoons \text{Co}^{2+}$	+1,81
$\text{F}_2(\text{g}) + 2e^- \rightleftharpoons 2\text{F}^-$	+2,87

Increasing reducing ability/Toenemende reduserende vermoë