



education

Department:
Education
PROVINCE OF KWAZULU-NATAL

**NATIONAL
SENIOR CERTIFICATE**

GRADE 10

LIFE SCIENCES

COMMON TEST

JUNE 2019

MARKS: 150

TIME: 2½ hours

This question paper consists of 17 pages.

INSTRUCTIONS AND INFORMATION

Read the following instructions carefully before answering the questions.

1. Answer ALL the questions.
2. Write ALL the answers in the ANSWER BOOK.
3. Start the answers to each question at the top of a NEW page.
4. Number the answers correctly according to the numbering system used in this question paper.
5. Present your answers according to the instructions of each question.
6. Do ALL drawings in pencil and label them in blue or black ink.
7. Draw diagrams, tables or flow charts only when asked to do so.
8. The diagrams in this question paper are NOT necessarily drawn to scale.
9. Do NOT use graph paper.
10. You may use a non-programmable calculator, protractor and a compass.
11. Write neatly and legibly.

SECTION A**QUESTION 1**

1.1 Various options are provided as possible answers to the following questions. Choose the answer and write only the letter (**A** to **D**) next to the question number (1.1.1 to 1.1.10) in the ANSWER BOOK, for example 1.1.11 D.

1.1.1 What is the magnification of a microscope whose eyepiece lens magnification is 10X and the objective lens magnification is 40X?

- A 50X
- B 400X
- C 4000X
- D 4X

1.1.2 Which of the following describes the behaviour of chromosomes during anaphase of mitosis?

- A Chromosomes align themselves along the equator of the cell
- B Each chromosome replicates and now has two chromatids
- C Chromatids of each chromosome separate and are pulled to opposite poles of the cell
- D Chromosomes appear as chromatin network

1.1.3 Which of the following is **not** a function of xylem vessels in plants?

- A Transport of water from the roots to the leaves
- B Mechanical support
- C Transport of sugars
- D Transport of dissolved minerals.

1.1.4 In which of the following cells or tissues does most of the photosynthesis take place?

- A Epidermal layer
- B Phloem vessels
- C Spongy mesophyll
- D Palisade layer

1.1.5 A grade 10 learner placed a clear plastic ruler across the centre of the field of view of a compound light microscope as shown below. A row of cells was seen under low-power magnification.

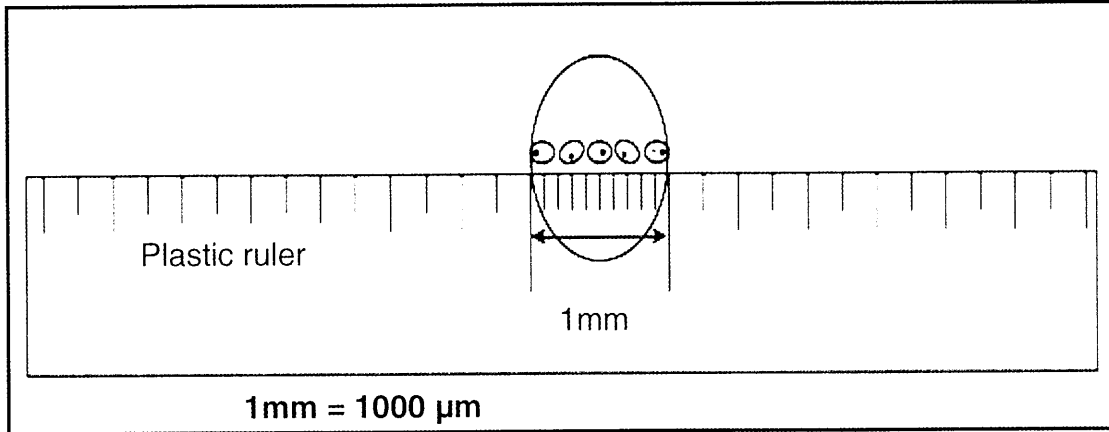

What is the average length of a single cell in micrometres (µm)?

- A 2000 µm
- B 10 µm
- C 200 µm
- D 100 µm

1.1.6 Living organisms such as animals have different levels of organisation. Study the diagram below and choose the structure represented by the LETTER X on the diagram.

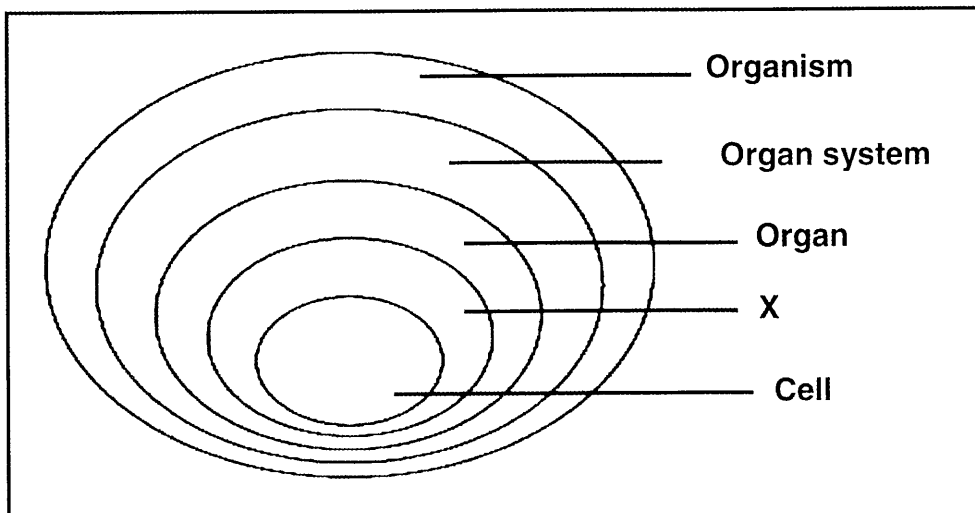

- A Tissue
- B Stomach
- C Intestines
- D Gut

1.1.7 The following bones are part of the axial skeleton except?

- A Vertebrae
- B Sternum
- C Scapula
- D Jaw bone

1.1.8 Which of the following statements about vaccines is correct?

- A They are antibiotics
- B They kill pathogenic organisms
- C They contain weakened concentrations of the real organism or toxin.
- D They are antigens that are produced by pathogens.

1.1.9 The following diagram shows the fluid mosaic model of the cell membrane.

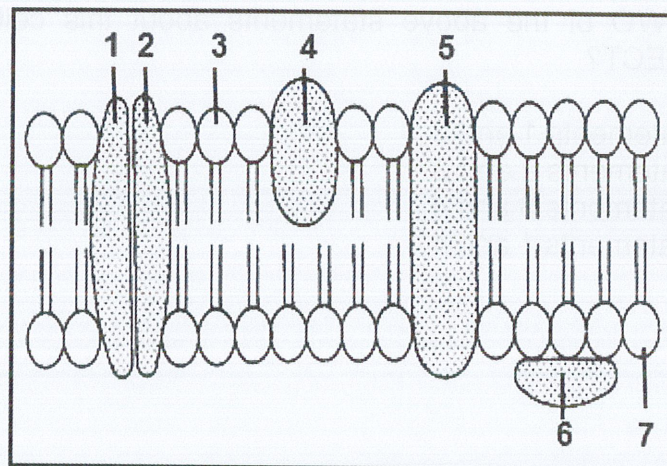

Which pair of structures numbered in the diagram is correctly identified in the table below?

	Protein	Phospholipid
A.	7	5
B.	5	3
C.	2	4
D.	3	1

- 1.1.10 The diagram below shows a special type of animal cell. Study the diagram and the four statements about it then answer the question based on it.

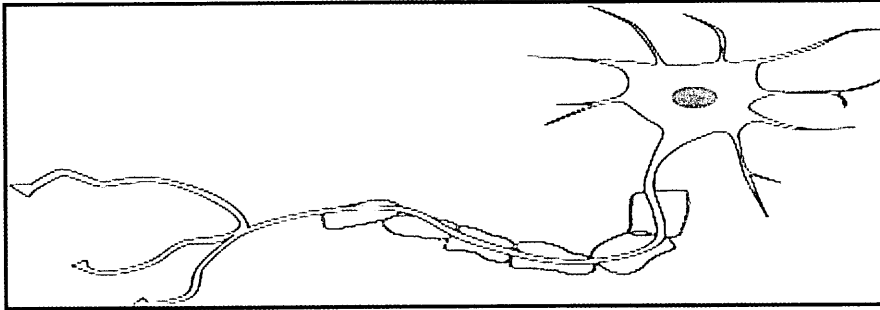

- (i) It is found between the spinal cord and the effector muscles
- (ii) It carries impulses from the dendrites to the motor end plate
- (iii) It is myelinated
- (iv) It is connected directly to the receptors.

Which TWO of the above statements about this cell are BOTH INCORRECT?

- A Statements 1 and 2
- B Statements 2 and 3
- C Statements 3 and 4
- D Statements 1 and 4

(10 x 2)

(20)

1.2 Give the correct **biological term** for each of the following descriptions. Write only the term next to the question numbers (1.2.1 to 1.2.7) in the ANSWER BOOK.

- 1.2.1 The site for protein synthesis in a cell
- 1.2.2 Structure that holds two chromatids together
- 1.2.3 Movement of a substance from a region of its high concentration to a region of its low concentration using energy from ATP
- 1.2.4 The substance upon which an enzyme acts
- 1.2.5 A pore in the epidermis of the leaf between two guard cells
- 1.2.6 Type of muscle found in tubular structures
- 1.2.7 Blood plasma that leaves blood capillaries and carries dissolved substances such as nutrients to body cells

(7 x 1) (7)

1.3 Indicate whether each of the statements in COLUMN I applies to **A ONLY, B ONLY, BOTH A AND B** or **NONE** of the items in COLUMN II. Write **A only, B only, both A and B**, or **none** next to the question number (1.3.1 to 1.3.3) in the ANSWER BOOK.

COLUMN I		COLUMN II	
1.3.1	Site for the synthesis of food in plants	A:	Chloroplast
		B:	Mitochondrion
1.3.2	Joins muscle to bone	A:	Ligament
		B:	Tendons
1.3.3	Loss of water vapour through the stomata	A:	Guttation
		B:	Transpiration

(3 x 2) (6)

- 1.4 Study the diagram of the human heart shown below and then answer the questions based on it.

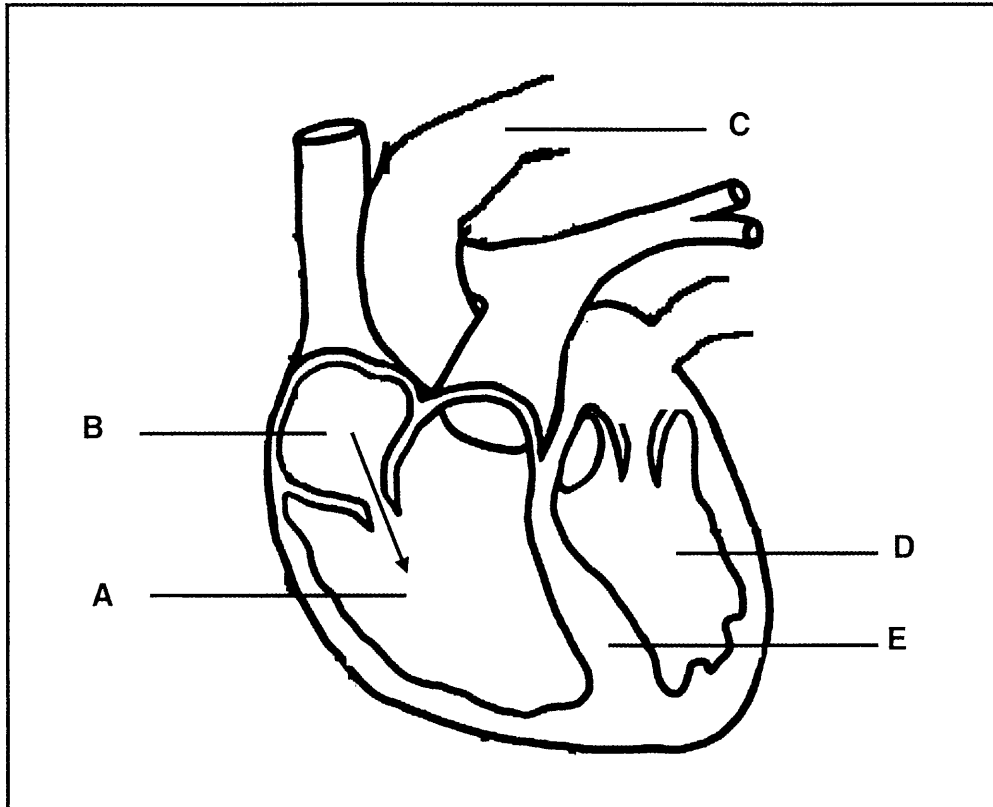

- 1.4.1 Name the parts labelled **B** and **E** on the diagram above. (2)
- 1.4.2 What type of blood moves in the direction shown by the arrow from **B** to **A**? (1)
- 1.4.3 Part **D** pumps blood to the rest of the body through the part labelled **C**. Describe one adaptation of part **D** that allows it to perform this function. (4)
- 1.4.4 Name the organ that receives blood from part labelled **A**. (1)
- 1.4.5 What name is given to the membrane surrounding the heart? (1)
- (9)**

1.5 Read the extract below.

Enzymes are used by the pulp and paper industry for the removal of glues, adhesives and coatings that are introduced to the pulp during the recycling of paper.

- 1.5.1 Define an *enzyme*. (2)
- 1.5.2 State ONE use of enzymes from the extract above. (1)
- 1.5.3 State THREE properties of enzymes. (3)
- 1.5.4 Name TWO uses of enzymes in industry other the ones mentioned in the extract. (2)
- (8)**

TOTAL SECTION A: 50

SECTION B**QUESTION 2**

2.1 The diagram below shows a type of cell.

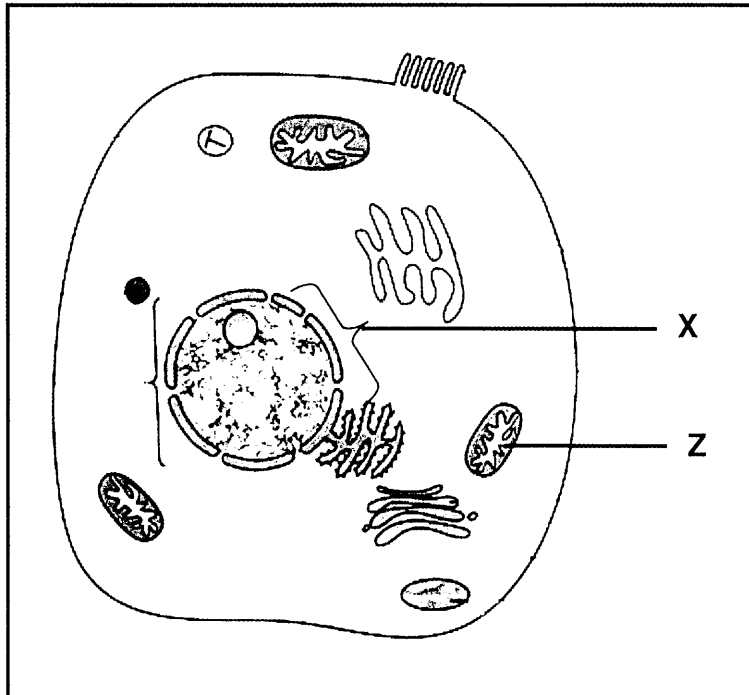

- 2.1.1 Is the above cell an animal cell or a plant cell? Give THREE reasons for answer. (4)
- 2.1.2 Identify organelles labelled **X** and **Z**. (2)
- 2.1.3 Explain TWO functions of the structure labelled **X**. (4)
- 2.1.4 Mention TWO functions of the cell membrane in all living cells. (2)
- (12)**

- 2.2 Below are micrographs of an animal tissue and a plant tissue. Study the diagrams and answer the questions that follow.

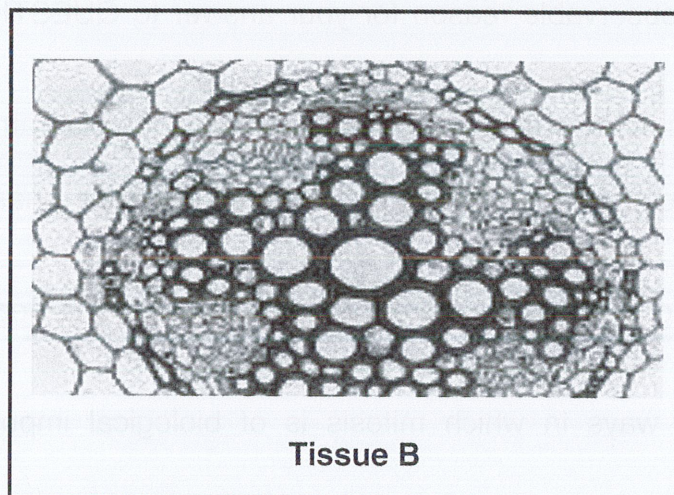
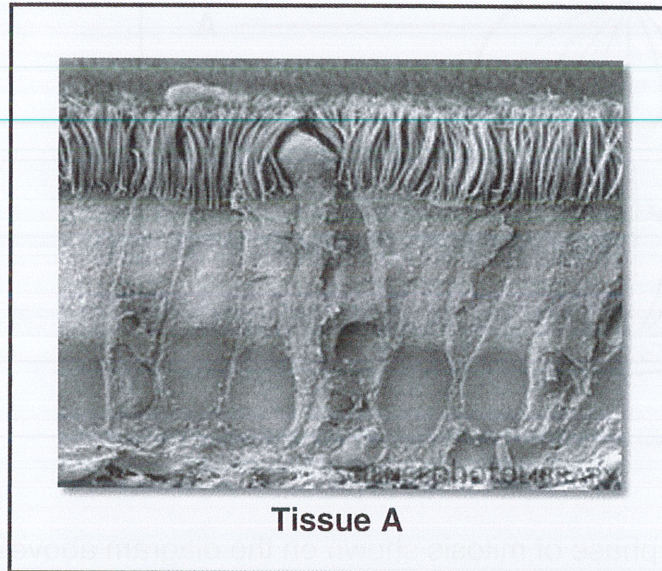

- 2.2.1 Give specific names for the following:
- (a) Tissue A (1)
 - (b) Tissue B (1)
- 2.2.2 Describe TWO structural adaptations of tissue B for its function. (4)
- 2.2.3 If tissue A was taken from the human respiratory system, which part would that be? (1)
- 2.2.4 Draw ONE fully labelled cell from tissue A. (4)
- (11)**

2.3 The diagram below shows a cell during a phase in mitosis.

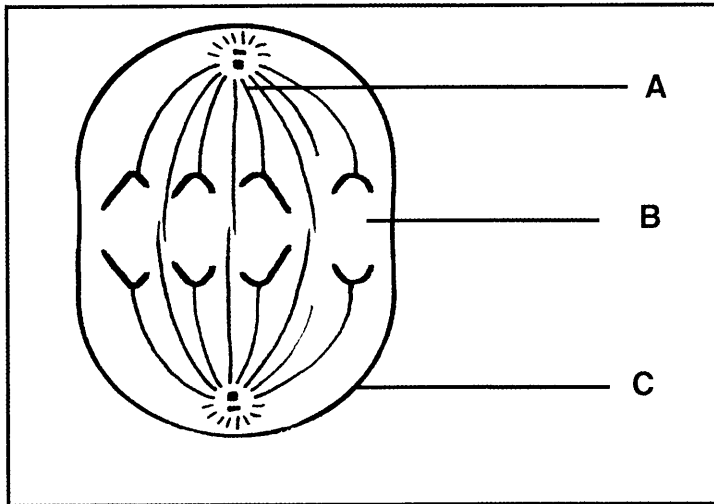

- 2.3.1 Identify the phase of mitosis shown on the diagram above? (1)
- 2.3.2 Give ONE observable reason for your answer to QUESTION 2.3.1 above. (2)
- 2.3.3 Give names of the parts labelled **A**, **B** and **C** on the diagram above. (3)
- 2.3.4 Name and describe the phase that occurs before the phase shown above. (3)
- 2.3.5 How many chromosomes were there in this cell at the beginning of mitosis? (2)
- 2.3.6 Give TWO ways in which mitosis is of biological importance in animals. (2)
- (12)**

2.4 At times cells may continue to divide by mitosis uncontrollably. Such cells are referred to as being cancerous.

- 2.4.1 Name any two causes of cancer. (2)
- 2.4.2 In what two ways can cancer be treated? (2)
- (4)**

[40]

QUESTION 3

A grade 10 class set up an experiment using the enzyme catalase found in raw chicken livers. Catalase has an optimum temperature of 37°C. The learners used the same amount of hydrogen peroxide and the same size of chicken liver pieces. The diagrams below show how they set up the experiment:

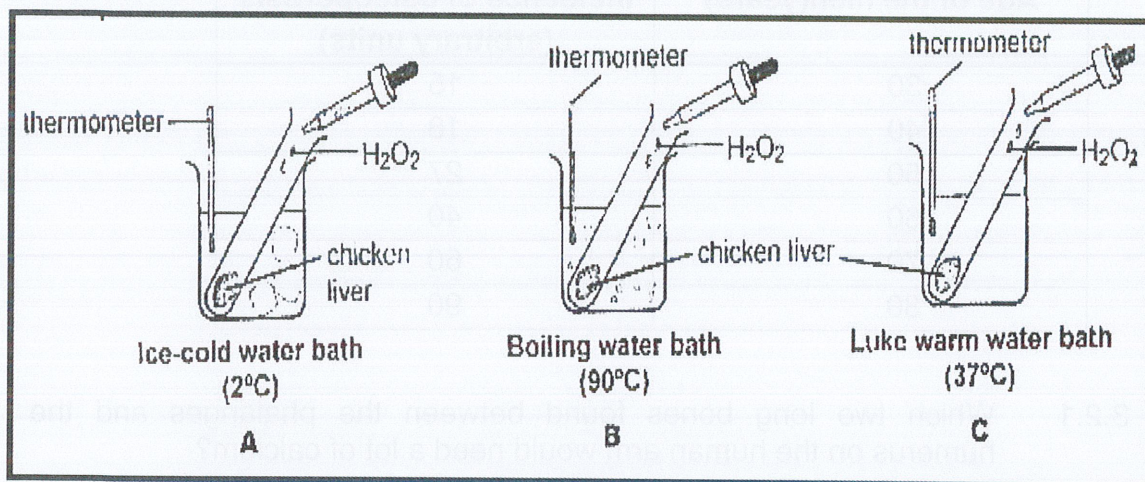

- 3.1.1 State a suitable aim for this experiment. (2)
- 3.1.2 What is meant by optimum temperature? (2)
- 3.1.3 Describe with reasons, the expected observations in test tubes **A** and **B** respectively? (4)
- 3.1.4 Identify the following in the above experiment:
- (a) The dependent variable (1)
 - (b) The independent variable (1)
- 3.1.5 State two ways stated in the procedure for the experiment that the learners followed to ensure that their results were accurate. (2)
- 3.1.6 If the chicken liver in test tube **B** was to be removed and placed at a temperature of 37°C, would the enzyme catalase in it work again? (1)
- (13)**

- 3.2 A study was carried out to find out the relationship between the age of a person and the gradual loss of calcium from the bones (osteoporosis) which causes them to break easily. The study was done on a group of 20 men from the age of 30 to 80 years.

Their bone densities were recorded as shown on the table below:

Age of the men(years)	Incidence of osteoporosis (arbitrary units)
30	15
40	18
50	27
60	40
70	60
80	90

- 3.2.1 Which two long bones found between the phalanges and the humerus on the human arm would need a lot of calcium? (2)
- 3.2.2 Give a reason for your answer to QUESTION 3.2.1 above. (2)
- 3.2.3 Use the information provided on the table to draw a line graph to represent the results of the investigation. (6)
- 3.2.4 From the graph that you have drawn, state the relationship between the age of the men and the incidence of osteoporosis. (2)
- (12)**

3.3 The photograph below shows the upper leg, knee and lower leg of a human.

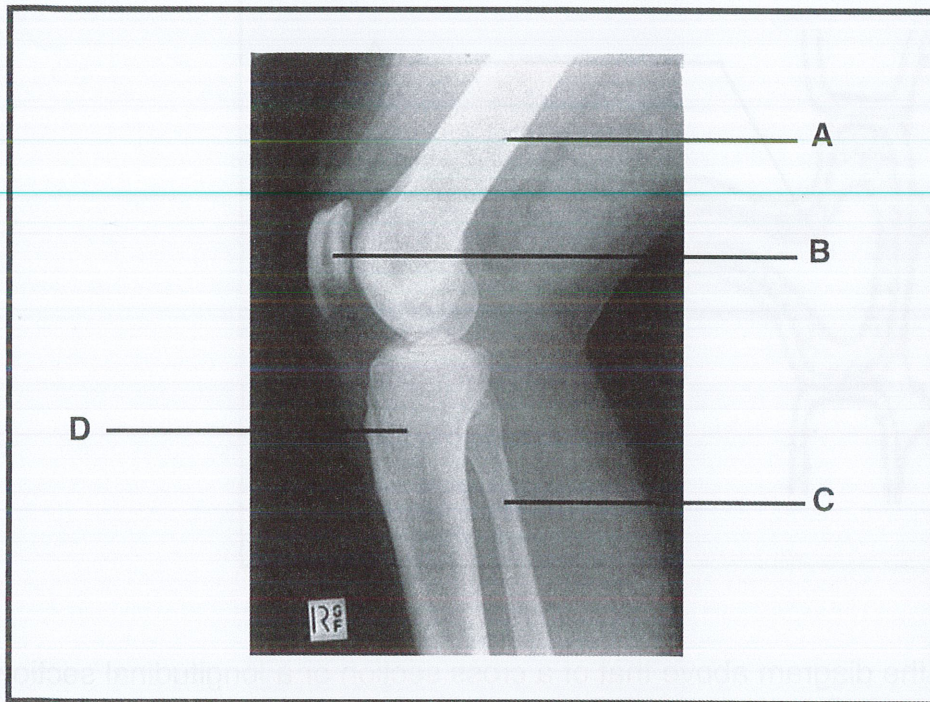

- 3.3.1 Provide labels for structures **B**, **C** and **D** respectively. (3)
- 3.3.2 Identify the type of synovial joint (between **A** and **D**) shown in the photograph above. (1)
- 3.3.3 Describe how friction is reduced at the type of joint mentioned in QUESTION 3.3.2 above. (2)
- 3.3.4 Name a disease of bones characterized by inflammation at a joint. (1)
- (7)

3.4 The diagram below shows a section through a young root.

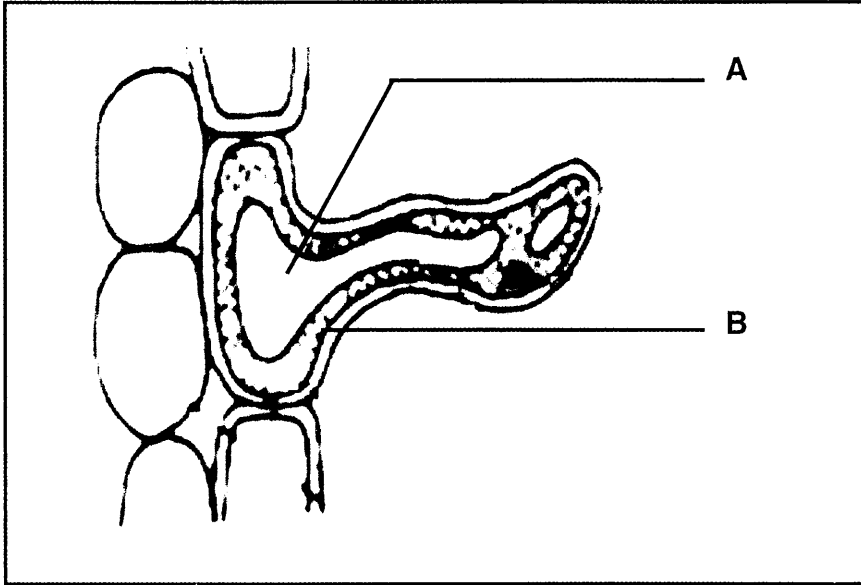

3.4.1 Is the diagram above that of a cross section or a longitudinal section of a root? (1)

3.4.2 Name the parts labelled **A** and **B**. (2)

3.4.3 Describe two structural adaptations of a root hair cell for its function. (4)

3.4.4 In which root tissue is a root hair cell found? (1)
(8)

[40]

TOTAL SECTION B: 80

SECTION C**QUESTION 4**

Describe the role of blood in transport of substances and in defence against pathogens. Also describe the structural suitability of arteries and veins for their functions.

Content:	17
Synthesis:	3
	(20)

NOTE: No marks will be awarded for answers in the form of a table, flow charts or diagrams.

TOTAL SECTION C: 20

GRAND TOTAL: 150



education

Department:
Education
PROVINCE OF KWAZULU-NATAL

LIFE SCIENCES

MARKING GUIDELINE

SEPTEMBER 2019

**NATIONAL
SENIOR CERTIFICATE**

GRADE 10

MARKS: 60

This marking guideline consists of 5 pages.

SECTION A**QUESTION 1**

1.1	1.1.1	D✓✓		
	1.1.2	B✓✓		
	1.1.3	A✓✓		
			(3 x 2)	(6)
1.2	1.2.1	Xerophytes ✓		
	1.2.2	Biome✓		
	1.2.3	Eukaryotes✓		
	1.2.4	Animalia✓		
			(4 x 1)	(4)
			TOTAL SECTION A:	10

SECTION B**QUESTION 2**

2.1	2.1.1	Food web ✓		(1)
	2.1.2	Energy flow ✓/ shows which organism feeds on another		(1)
	2.1.3	(a) Lion✓ / Hyena/hawk		(1)
		(b) Rabbit ✓/ Impala / Buffalo		(1)
	2.1.4	It feeds on Rabbits✓ and Buffalo ✓		(2)
	2.1.5	Hawk ✓		(1)
	2.1.6	Feeds only on Rabbits✓ / No other food source for Hawk on this food web.		(1)
	2.1.7	Number of Hyenas will increase✓ due to more food available to them ✓/ less competition for food from Lions		(2)
				(10)

2.2	2.2.1	Carolus Linnaeus ✓		(1)
	2.2.2	(a) Genus ✓ / Genera		(1)
		(b) Species ✓		(1)
	2.2.3	Common characteristics ✓ / features		(1)
	2.2.4	Mammalia ✓ / mammals		(1)
				(5)
				[15]
3.1	3.1.1	-Decide on the sample size ✓ -Decide on how to record results ✓ -Decide on apparatus to be used ✓ -Decide on duration of the investigation ✓ -Decide on the method to be used ✓ -decide on the age of the plants to be used ✓	Any	(2)
	3.1.2	Plant type ✓		(1)
	3.1.3	Plant type C ✓		(1)
	3.1.4	-Same amount of water ✓ -Same temperature ✓ -Same duration of investigation ✓ -same species of plant ✓ -same amount of light ✓	Any	(1)

3.1.5 Bar graph showing the effect of alkaline pH on root growth of plant Type

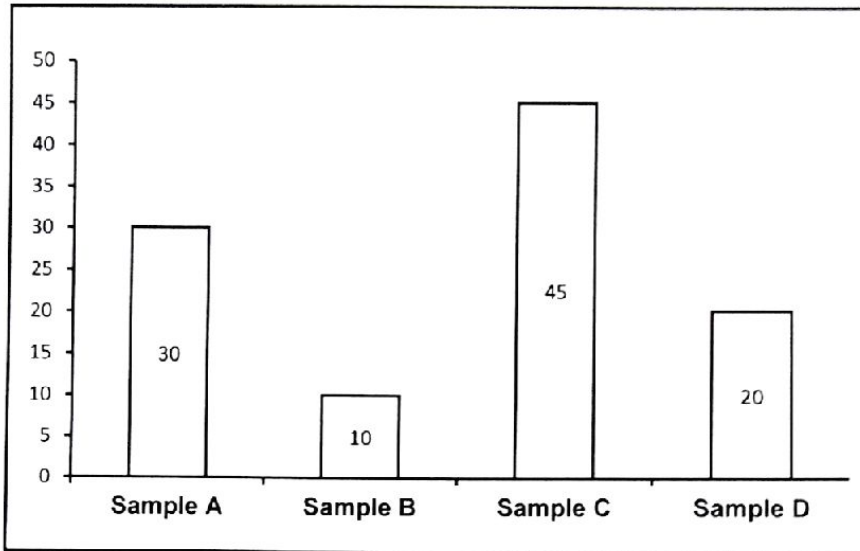

Rubric for marking Graph

	Mark allocation
Correct type of graph	1
Correct caption for graph	1
Correct label on X and Y axis	1
Correct scale on x and y axis	1
Plotting of bars	1 (1 to 2 bars)
	2 (all 4 bars)
Note: if the wrong graph is drawn, marks will be lost for correct type of graph. If axes are transposed, marks will be lost for labelling of X-axis and Y-axis.	

(6)
(11)

3.2 3.2.1 Radiation ✓ /wind velocity

(1)

3.2.2 Rapid surface runoff ✓/soil erosion/ soil degradation.

(1)

3.2.3 - South-facing side receives less solar radiation ✓ /sun
- Will therefore be cooler ✓/loses less water / there will be less transpiration/ evaporation compared to North-facing side.

Any (2)
(4)

TOTAL SECTION B:

(15)
30

SECTION C**Question 4****Water cycle (W)**

- water evaporates from the oceans ✓ / rivers / dams / lakes
- water vapour leaves plants through transpiration ✓
- the water vapour rises ✓ and condenses ✓ to form clouds ✓
- precipitation falls as rain ✓ / hail / snow / ice / dew /
- Water runs into streams ✓ / rivers / lakes / oceans
- Then evaporation takes places all over again ✓

(Any 7) (7)**Oxygen cycle (O)**

- Living organisms take in oxygen ✓ during respiration ✓
- And they release carbon dioxide ✓ into the atmosphere
- Plants use / take in carbon dioxide ✓ for photosynthesis ✓
- Plants release oxygen ✓ as a by-product of photosynthesis **(Any 5) (5)**

Ecotourism (E)

- People can visit protected areas ✓ / relatively unexplored natural areas
- without causing any damage ✓ or change to the area
- Gives local communities financial benefits ✓ / creates jobs for local people
- Allows local people to use natural resources in the ecotourism area ✓
- Gives awareness to local communities ✓ on the need to conserve their natural resources ✓
- Can earn foreign currency for the country ✓ **(Any 5) (5)**

ASSESSING THE PRESENTATION OF THE ESSAY

Relevance	Logic sequence	Comprehensive
All information provided is relevant to the question	Ideas arranged in a logical cause-effect sequence	Answered all aspects required by the essay in sufficient detail
All the information provided is relevant to the water cycle, Oxygen cycle and ecotourism	All the information regarding the water cycle, oxygen cycle and ecotourism is arranged in a logical manner.	At least the following points should be obtained: water cycle: 5/7. Oxygen cycle: 3/5 Ecotourism: 3/5
1 mark	1 mark	1 mark

TOTAL SECTION C: 20
GRAND TOTAL: 60